



LED SOLAR STREET LIGHT

โคมไฟถนน LED โซล่าเซลล์

ทางเลือกใหม่
สำหรับการประหยัดพลังงาน



BATMAN Series



BEAN STALK Series



AIRSHIP Series

ให้ความสว่างตาม
มาตรฐานไฟถนนหลวง



T8 LED Tube Lamp

หลอดไฟ ออฟฟิศ สำนักงานทั่วไป



ผลิตภัณฑ์ มีสตอร์ลูเมน | จัดจำหน่ายโดย บริษัท ชันคอร์ เวิลด์วีดี จำกัด



TABLE OF CONTENTS



BATMAN
Series



AIRSHIP
Series



BEAN STALK
Series



T8 LED
Tube Lamp



LED SOLAR STREET LIGHT BATMAN SERIES

โคมไฟถนน LED โซล่าเซลล์

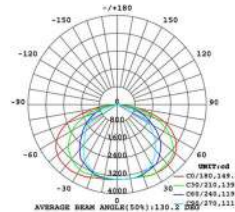

PARAMETERS

Model No.	BMS-20	BMS-40	BMS-70	BMS-90	BMS-120
Solar Panel	20W	35W	55W	60W	80W
Light Power	15W	25W	35W	45W	60W
Battery (LiFePO4)	116WH	231WH	384WH	460WH	576WH
Luminous flux	2000lm	4000lm	7000lm	9000lm	12000lm
Recommended installation height	3-4m.	4-5m.	4-6m.	6-8m.	7-9m.
Recommended mounting distance	15m.	20m.	25m.	25m.	30m.
Warranty	3 Years				
LED Chip	NICHIA				
CCT	4000K-6500K				
Beam angle	TYPE III				
Lamp angle	0/30 degree vertically				
PIR Sensor	Yes (Optimum detecting range: 6-8 m)				
Battery backup time	3 night				
Standard Working Mode	First 3 hours full brightness, last 9 hours in dimmable mode (60% brightness with people, 30% brightness without people)				
Working temperature	-20°C to 60°C				
Charging time	7-9 hours				
Required pole size	60 mm (top end)				
IP/IK Class	IP66 / IK08				
Wind proof	pass the 60/s wind loading wind proof real testing				



About **Batman** Series

Up to 8 Years lifetime

- Energy Management System (EMS) : ensure the product can light up every day even at 10 days consecutive rainy weather
- Germany Imported silicon solar panel, Up to 21% conversion rate.
- 6 years lifetime, 3 years warranty ternary lithium battery.
- 8 years lifetime, 3 years warranty LiFePO4 lithium battery.
- Suitable to use at 60 centi-degree ambient temperature.
- IP66 Waterproof, 16 grade wind proof.



BMS-120 12000lumens

Solar Panel	Light Power	Battery	LED Chip
80W	60W	576WH	NICHIA

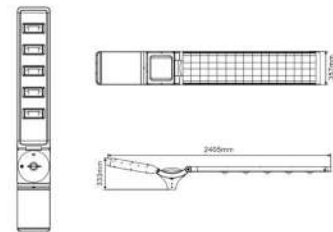
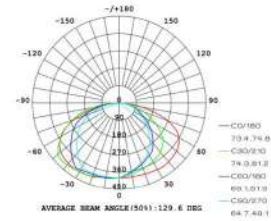

BMS-90 9000lumens

Solar Panel	Light Power	Battery	LED Chip
60W	45W	460WH	NICHIA

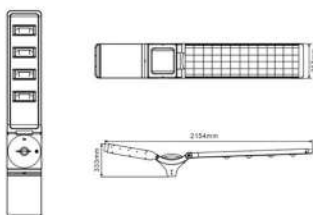
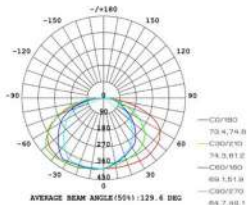

BMS-70 7000lumens

Solar Panel	Light Power	Battery	LED Chip
55W	35W	384WH	

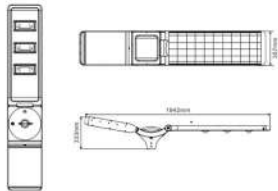
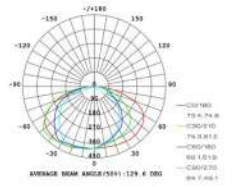

BMS-40 4000lumens

Solar Panel	Light Power	Battery	LED Chip
35W	25W	231WH	

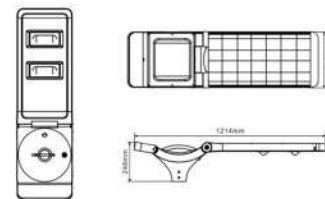
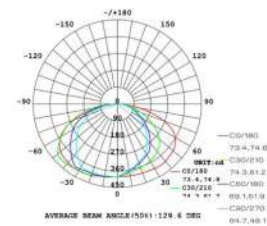

BMS-20 2000lumens

Solar Panel	Light Power	Battery	LED Chip
20W	15W	116WH	

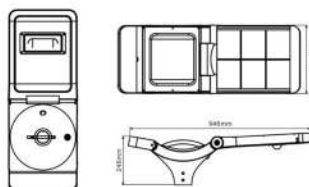
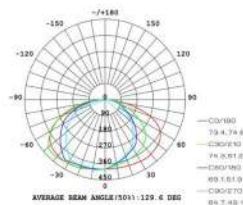



LED SOLAR STREET LIGHT AIRSHIP SERIES

โคมไฟถนน LED โซล่าเซลล์

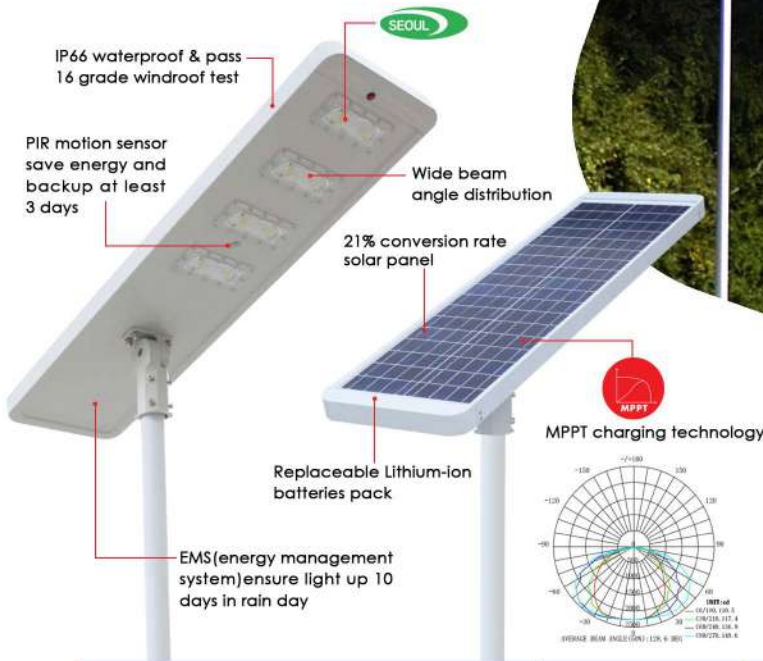

PARAMETERS

Model No.	EBM-30	EBM-40	EBM-60	EBM-80
Solar Panel	40W	60W	70W	90W
Light Power	30W	40W	60W	80W
Battery	222WH	388.5WH	444WH	583WH
Luminous flux	4200lm	5500lm	8100lm	11000lm
Recommended installation height	4-5m.	4-6m.	6-8m.	7-9m.
Recommended mounting distance	15m.	20m.	25m.	25m.
Warranty	2 Years			
LED Chip				
CCT	4000K-6500K			
Beam angle	TYPE III			
Lamp angle	0/15/30 degree vertically			
PIR Sensor	Yes (Optimum detecting range: 6-8 m)			
Battery backup time	3 night			
Standard Working Mode	First 3 hours full brightness, last 9 hours in dimmable mode (60% brightness with people, 30% brightness without people)			
Working temperature	-20°C to 60°C			
Charging time	7-9 hours			
Required pole size	60 mm (top end)			
IP/IK Class	IP66 / IK08			



EBM-80 11000lumens

Solar Panel	Light Power	Battery	LED Chip
90W	80W	583WH	

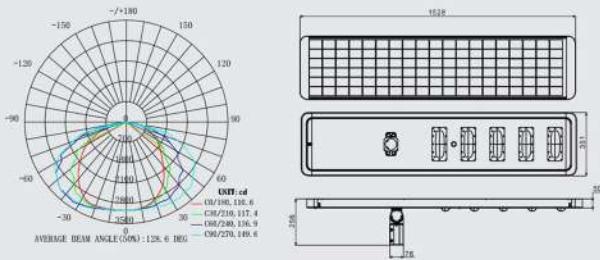

EBM-60 8100lumens

Solar Panel	Light Power	Battery	LED Chip
70W	60W	444WH	

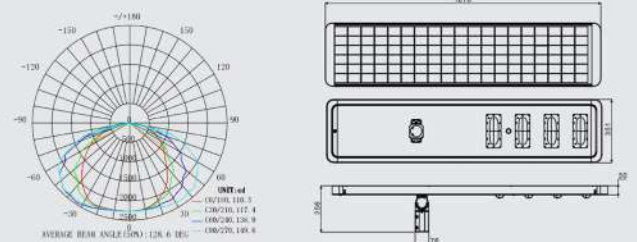

EBM-40 5500lumens

Solar Panel	Light Power	Battery	LED Chip
60W	40W	388.5WH	

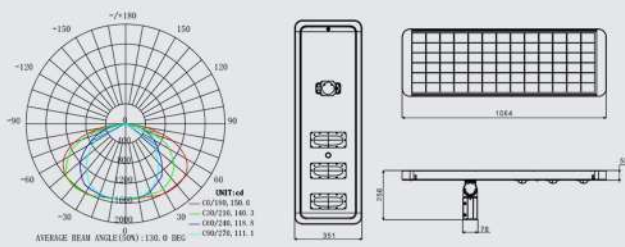

EBM-30 4200lumens

Solar Panel	Light Power	Battery	LED Chip
40W	30W	222WH	

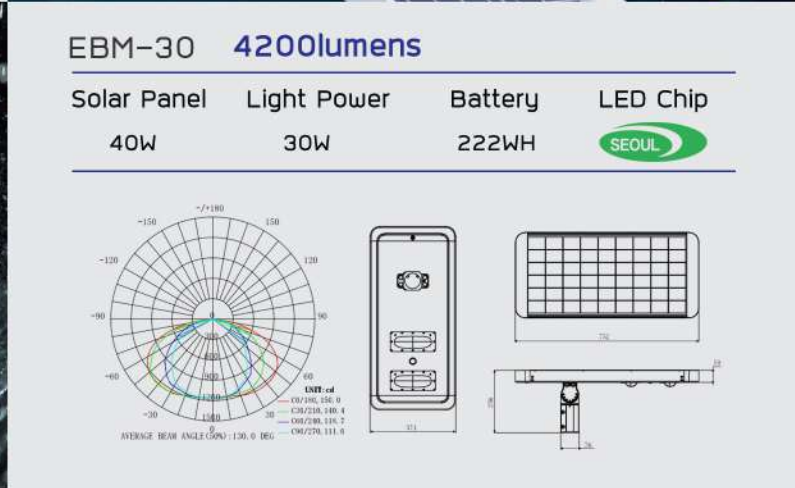
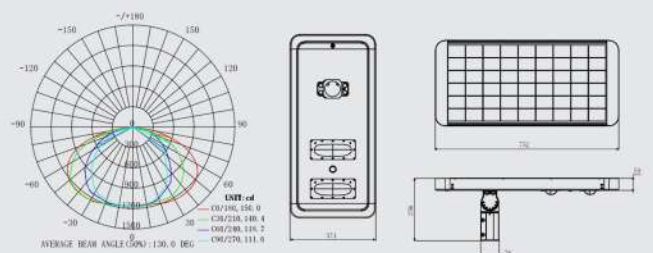

โคมไฟสวน LED โซล่าเซลล์

EMS(energy management system)ensure light up 10 days in rainy weather

IP66 waterproof

Replaceable Lithium-ion batteries pack

21% conversion rate solar panel

Dual lens system 360 degree lighting distribution

PIR motion sensor save energy

MPPT charging technology



PARAMETERS

Model No.	BST-16
Solar Panel	25W
Light Power	16W
Battery	138.8WH
Luminous flux	2500lm
Recommended installation height	3-5m.
Recommended mounting distance	10-20m.
Warranty	2 Years (Lifetime 6-8 years)
LED Chip	
CCT	5000K-6500K
Beam angle	360 degree
Battery backup time	3 days
Dim mode	First 5 hours : 50% brightness, last 5 hours in dimming mode (100% with people, 20% without people)
Working temperature	-20°C to 60°C
Charging time	9-11 hours
Required pole size	60 mm (top end)



โคมไฟสวน LED โซล่าเซลล์

Product size and Packing info

Unit : mm

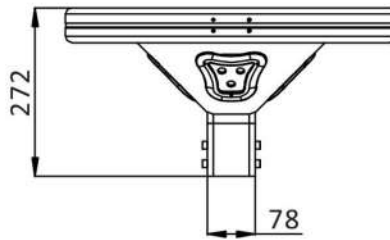
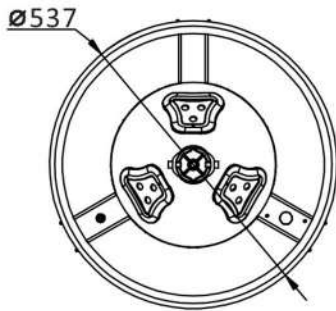

Model No.	Qty	Carton Size	N.W.(kgs)	G.W.(kgs)	20ft container	40ft container
BST-16	1pcs/ctn	640*640*345mm	8	11	16	432

Applications

Widely used in the road, street, factory, park road, rural, mountainous area and the remote area lighting project, courtyard, schools, square and other need to place for outdoor lighting



บริษัท มีสเดอริลูเมน | จัดจำหน่ายโดย บริษัท ชันคอรี เซ็นเนอริบี จำกัด



หลอดไฟ ออพเพ็ค สำหรับงานทั่วไป

T8 LED Tube Lamp

รุ่น CH1351A Series

Product Description

The CH1351A T8 LED tube lamp provides exceptional LED lighting with reduced energy and maintenance costs. This lamp has a particularly wide beam spread of 160 degree and rated lifetime of 50,000hours. This CH1351A does not require a ballast to work with and offers a built-in universal line voltage driver, making it a top-of-the-line replacement for standard fluorescent lamps.

Tube Features

- * Simple rewiring installation allows lamps to operate on main line voltage
- * Wide beam design- 160 degree light emitting area
- * Exceptional efficacy- 112 LPW/150 LPW
- * Safe explosion-proof cover
- * High transmittance

Product Specification



RoHS



Product	Lamp Power(W)	PF	Lumen (lm@4000K)	CCT (K)	CRI	Lifetime (hrs)	Socket	Dimension (mm)	Beam Angle (°)
CH1351A	9	>0.9	1000	3000/4000/6500	83	50000	G13	φ26x600	160
CH1351A	18	>0.9	2000	3000/4000/6500	83	50000	G13	φ26x1200	160
CH1351A	24	>0.9	2680	3000/4000/6500	83	50000	G13	φ26x1500	160
CH1351A	9	>0.9	1170	3000/4000/6500	83	50000	G13	φ26x600	160
CH1351A	18	>0.9	2340	3000/4000/6500	83	50000	G13	φ26x1200	160
CH1351A	24	>0.9	3200	3000/4000/6500	83	50000	G13	φ26x1500	160
CH1351A	9	>0.9	1350	3000/4000/6500	83	50000	G13	φ26x600	160
CH1351A	18	>0.9	2700	3000/4000/6500	83	50000	G13	φ26x1200	160
CH1351A	24	>0.9	3600	3000/4000/6500	83	50000	G13	φ26x1500	160

T8 Series

Linear LED Tube



ผลิตภัณฑ์ มีสเตอร์ลูเมน | จัดจำหน่ายโดย บริษัท ชันคอรี เวิลด์วอร์รี่ จำกัด





หลอดไฟ ออพพืค สำหรับงานทั่วไป

T8 LED Tube Lamp

รุ่น CH1753 Series



Product Description

The CH1753 T8 LED tube lamp provides exceptional LED lighting with reduced energy and maintenance costs. This lamp has a particularly wide beam spread of 160 degree and rated lifetime of 50,000 hours. This CH1753 does not require a ballast to work with and offers a built-in universal line voltage driver making it a top-of-the-line replacement for standard fluorescent lamps.

Tube Features

- * Simple rewiring installation allows lamps to operate on main line voltage
- * Wide beam design – 160 degree light emitting area
- * Exceptional high efficacy – 170 LPW
- * Safe explosion-proof cover
- * High transmittance
- * Material : Nano plastic

Product Model



RoHS



Product	Lamp Power(W)	PF	Lumen (lm@6500K)	CCT (K)	CRI	Lifetime (hrs)	Socket	Dimension (mm)	Beam Angle (°)
CH1753	12.7	>0.95	2300	3000/4000/6500	83	50000	G13	φ26x1200	160

T8 Series Linear LED Tube



บริษัท มีสเตอร์ลูเมน | จัดจำหน่ายโดย บริษัท ชันคอรี เวิลด์ไวด์ จำกัด

LUMENS



Distributed by

SUNKOR ENERGY CO., LTD.

10 Sopha Village, Soi Ngamwongwan1/1,
Bang Kraso, Nonthaburi 11000

www.sunkorenergy.com

